

SGM4890

1.1 Watt Audio Power Amplifier

GENERAL DESCRIPTION

The SGM4890 is a 1.1-W, fully integrated, audio power amplifier. It is designed to maximize audio performance in portable applications such as mobile phone. The portable application requires audio power amplifier has minimum of external components and can operate from a single 2.5V to 5.5V power supply. SGM4890 is capable of delivering 1.1W of continuous output power with less than 1% distortion (THD + N) when it drives an 8Ω speaker from a 5.0V power supply.

The SGM4890 features a low-power consumption shutdown mode, which is achieved by driving the shutdown pin with a logic low. Additionally, the SGM4890 features an internal thermal shutdown protection mechanism.

The SGM4890 does not require output coupling capacitors or bootstrap capacitors, and therefore is ideally suited for mobile phone and other low voltage applications where minimal power consumption is a primary requirement.

For maximum flexibility, the SGM4890 provides an externally controlled gain (with resistors), as well as an externally controlled turn-on time (with the bypass capacitor). When using a 1μF bypass capacitor, it offers 110ms wake up time when V+ is equal to 5.0V.

The SGM4890 is available in CSP-9 and MSOP-8 packages. It operates over an ambient temperature range of -40 to +85 .

APPLICATIONS

- Portable Systems
- MP3 Players
- Mobile Phone
- PDA's
- GPS

FEATURES

- Ideal for Notebook Computers, PDA's, and Other Small Portable Audio Devices
- 1.1W to 8-Ω BTL Load from 5V Supply at THD =1% (Typical)
- Excellent PSRR: Direct Connection to the Battery
- Fast Turn On Time
- Unity Gain Stable
- 2.5V to 5.5V Operation
- Shutdown Current: 0.01μA Typical
- Shutdown Pin is Compatible with 1.8V Logic
- -40 to +85 Operating Temperature Range
- Small Packaging

PIN CONFIGURATIONS (Top View)

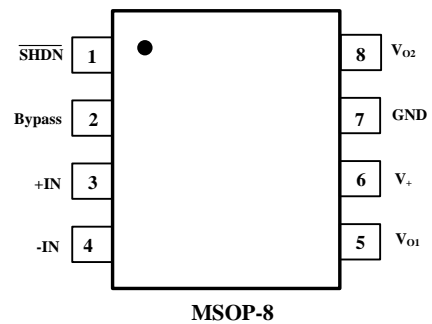
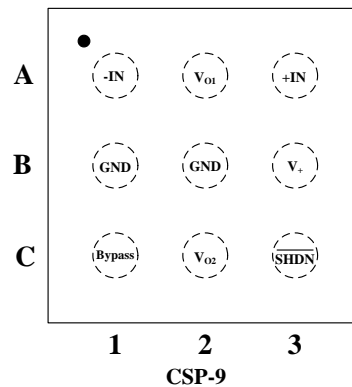

ELECTRICAL CHARACTERISTICS : TA = 25

| PARAMETER | SYMBOL | CONDITIONS | SGM4890 | | | UNITS | |
|-----------------------------------|-------------------|--|----------------------------------|------|------|-------|----|
| | | | MIN | TYP | MAX | | |
| Quiescent Power Supply Current | I _Q | V _{IN} = 0V, I _O = 0A, | V ₊ = +5V, No Load | | 4 | 8 | mA |
| | | | V ₊ = +5V, 8 Ω Load | | 6 | 10 | |
| | | | V ₊ = +3.6V, No Load | | 3.7 | | |
| | | | V ₊ = +3.6V, 8 Ω Load | | 5.7 | | |
| | | | V ₊ = +3.0V, No Load | | 3.5 | 7 | |
| | | | V ₊ = +3.0V, 8 Ω Load | | 5.5 | 9 | |
| | | | V ₊ = +2.6V, No Load | | 3.3 | | |
| | | | V ₊ = +2.6V, 8 Ω Load | | 5.3 | | |
| Shutdown Current | I _{SD} | V _{SHUTDOWN} = 0V, | | 0.01 | 4.0 | μA | |
| Shutdown Voltage Input High | V _{SDIH} | | 1.2 | | | V | |
| Shutdown Voltage Input Low | V _{SDIL} | | | | 0.4 | V | |
| Output Offset Voltage | V _{OS} | | | 1 | 50 | mV | |
| Output Power (8 Ω) | P _O | f = 1 kHz, THD+N=1% | V ₊ = +5V | | 1.10 | | W |
| | | | V ₊ = +3.6V | | 0.58 | | |
| | | | V ₊ = +3.0V | | 0.40 | | |
| | | | V ₊ = +2.6V | | 0.30 | | |
| Total Harmonic Distortion + Noise | THD+N | P _O = 0.4Wrms, f = 1kHz | | 0.01 | | % | |
| Power Supply Rejection Ratio | PSRR | f = 217Hz | V ₊ = +5V | | -66 | | dB |
| | | | V ₊ = +3.6V | | -63 | | |
| | | | V ₊ = +3.0V | | -63 | | |
| | | | V ₊ = +2.6V | | -62 | | |
| | | f = 1kHz | V ₊ = +5V | | -72 | | |
| | | | V ₊ = +3.6V | | -68 | | |
| | | | V ₊ = +3.0V | | -66 | | |
| | | | V ₊ = +2.6V | | -64 | | |
| Wake –up Time | T _{WU} | C _{BYPASS} = 1μF | V ₊ = +5V | | 110 | | ms |
| | | | V ₊ = +3.6V | | 110 | | |
| | | | V ₊ = +3.0V | | 100 | | |
| | | | V ₊ = +2.6V | | 100 | | |
| Shut Down Time | T _{SdT} | 8 Ω Load | V ₊ = +5V | | 10 | | μs |
| | | | V ₊ = +3.6V | | 16 | | |
| | | | V ₊ = +3.0V | | 17.8 | | |
| | | | V ₊ = +2.6V | | 17.8 | | |

Specifications subject to changes without notice.

PACKAGE/ORDERING INFORMATION

| MODEL | ORDER NUMBER | PACKAGE DESCRIPTION | PACKAGE OPTION | MARKING INFORMATION |
|---------|---------------|---------------------|---------------------|---------------------|
| SGM4890 | SGM4890YG/TR | CSP-9 | Tape and Reel, 3000 | 4890YG |
| | SGM4890YMS/TR | MSOP-8 | Tape and Reel, 3000 | SGM4890YMS |

ABSOLUTE MAXIMUM RATINGS

Supply Voltage 6V
 Input Voltage (-Vs) - 0.3 V to (+Vs) +0.3V
 Storage Temperature Range -65 to +150
 Junction Temperature 150
 Operating Temperature Range -40 to +85
 Lead Temperature Range (Soldering 10 sec)
 260

NOTES

- Stresses above those listed under Absolute Maximum Ratings may cause permanent damage to the device. This is a stress rating only; functional operation of the device at these or any other conditions above those indicated in the operational section of this specification is not implied. Exposure to absolute maximum rating conditions for extended periods may affect device reliability.

CAUTION

This integrated circuit can be damaged by ESD. SG Micro-electronics recommends that all integrated circuits be handled with appropriate precautions. Failure to observe proper handling and installation procedures can cause damage.

ESD damage can range from subtle performance degradation to complete device failure. Precision integrated circuits may be more susceptible to damage because very small parametric changes could cause the device not to meet its published specifications.

TYPICAL APPLICATION

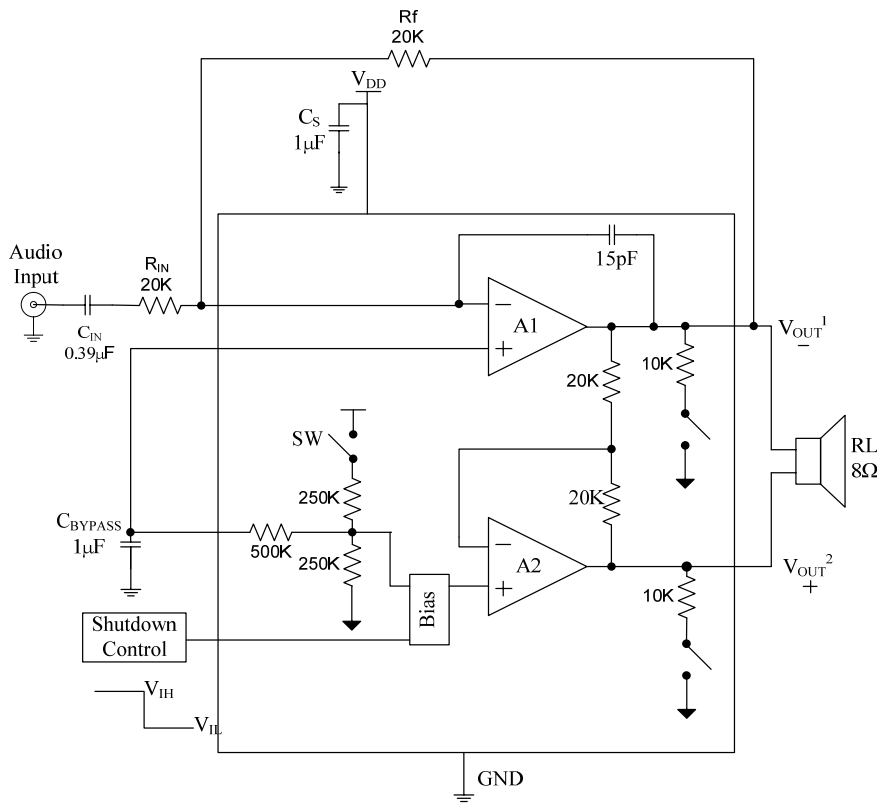

TYPICAL PERFORMANCE CHARACTERISTICS

V_{OUT+} or V_{OUT-} Large Sine Signal Response

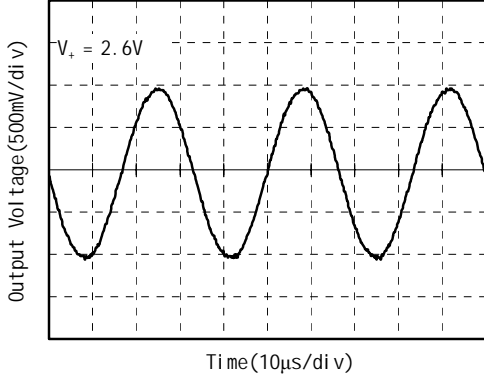

Large Signal Step Response

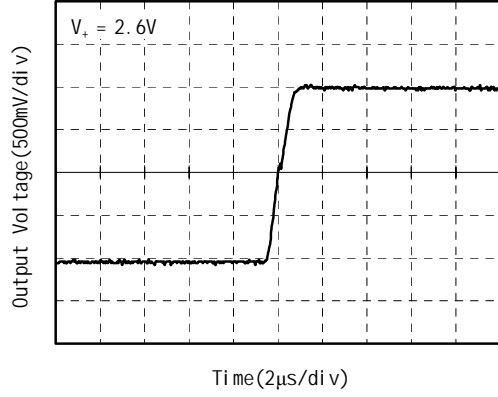

V_{OUT+} or V_{OUT-} Large Sine Signal Response

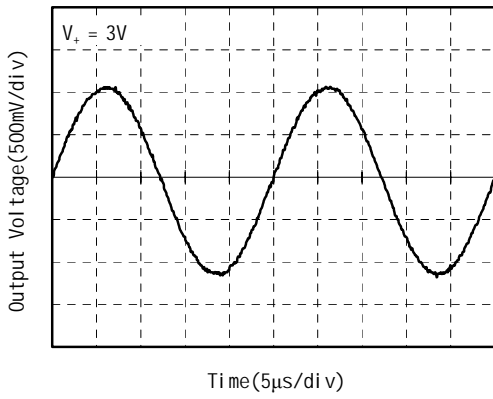

Large Signal Step Response

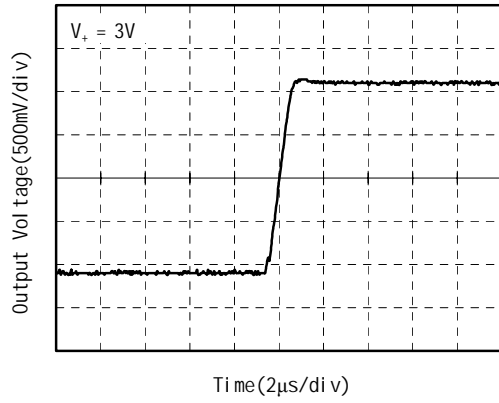

V_{OUT+} or V_{OUT-} Large Sine Signal Response

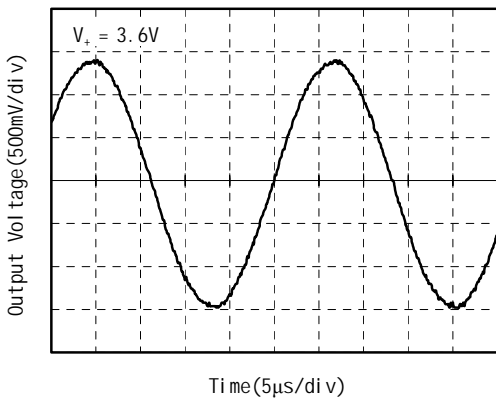

Large Signal Step Response

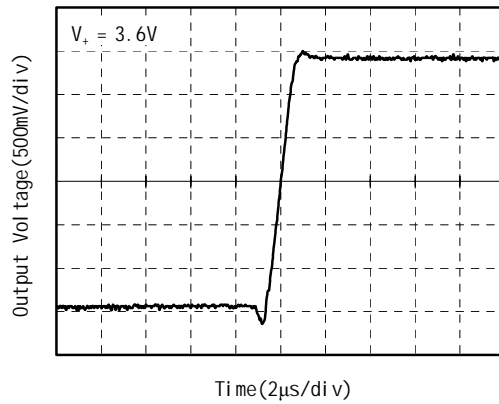

TYPICAL PERFORMANCE CHARACTERISTICS

V_{OUT+} or V_{OUT-} Large Sine Signal Response

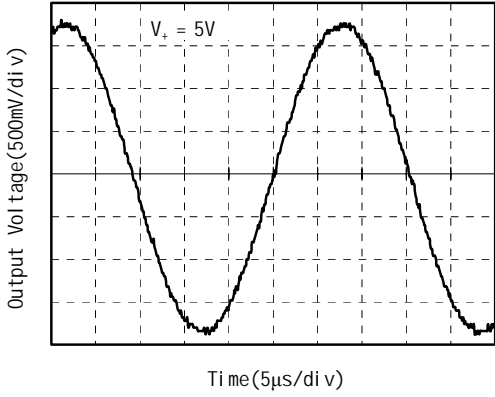

Large Signal Step Response

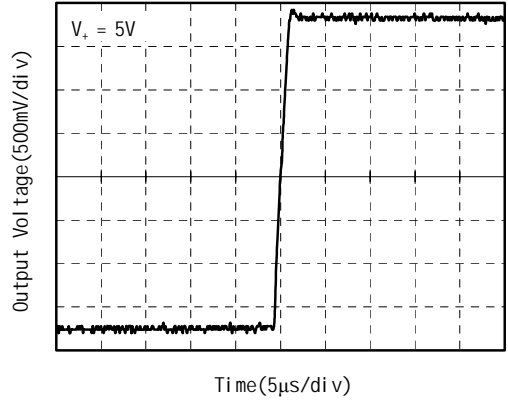

Small Signal Frequency Response

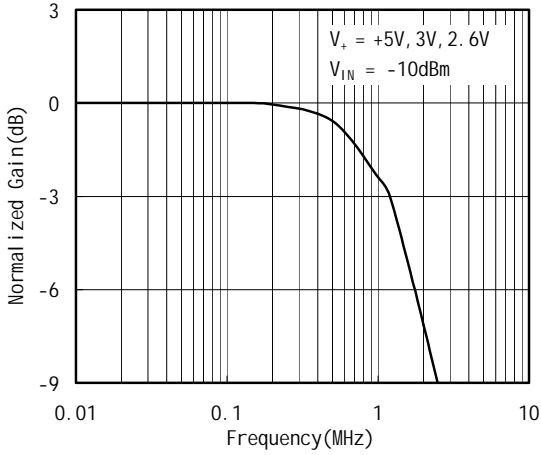

Quiescent Current vs. Temperature

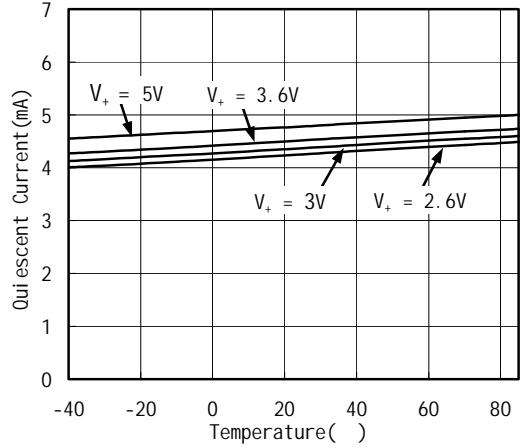

Output Offset Voltage vs. Temperature

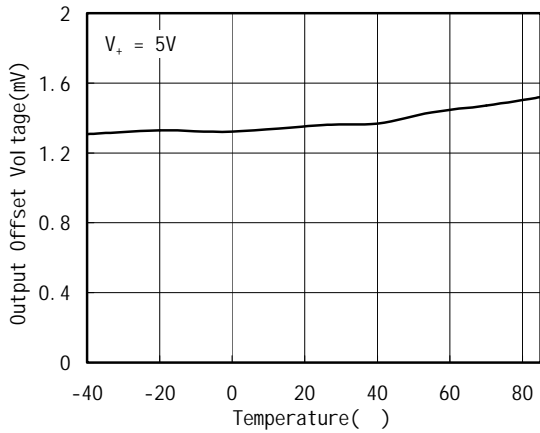

Supply Current vs. Shutdown Voltage

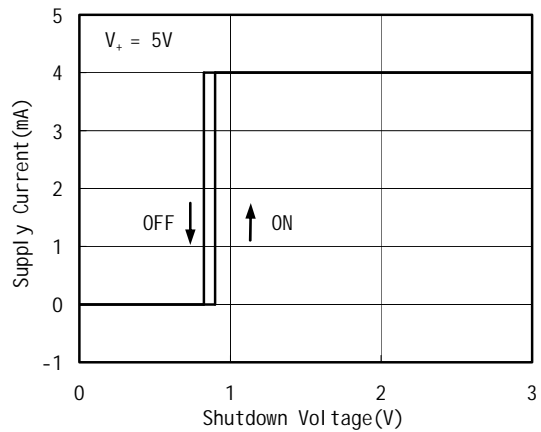

TYPICAL PERFORMANCE CHARACTERISTICS

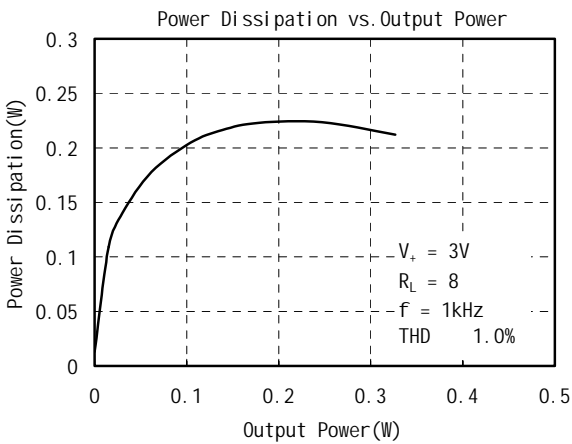
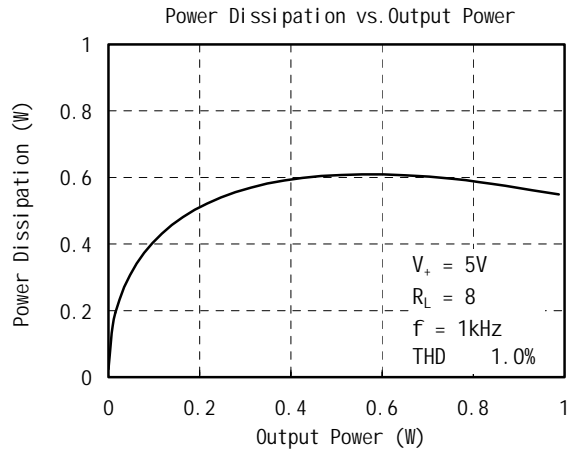
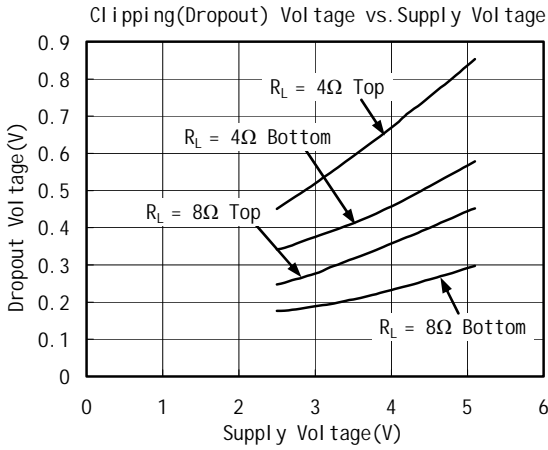
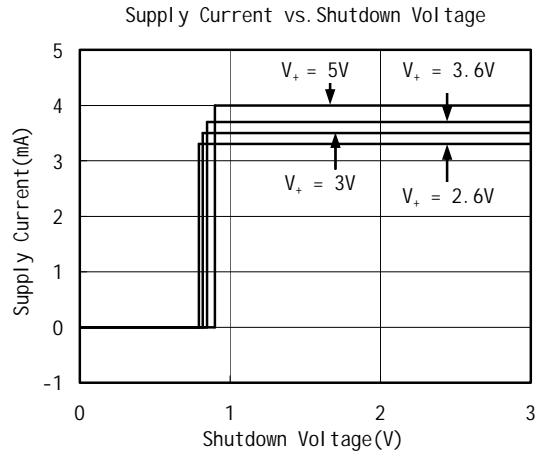
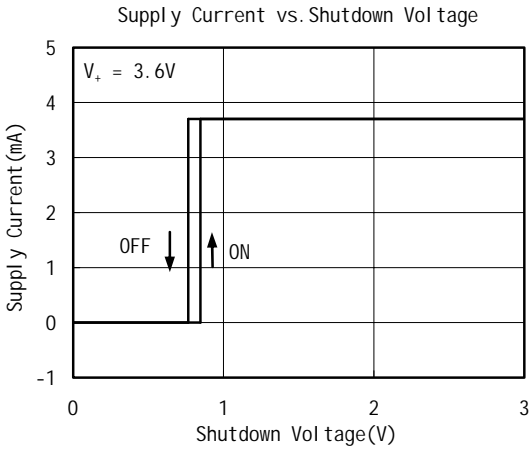

PACKAGE OUTLINE DIMENSIONS

MSOP-8

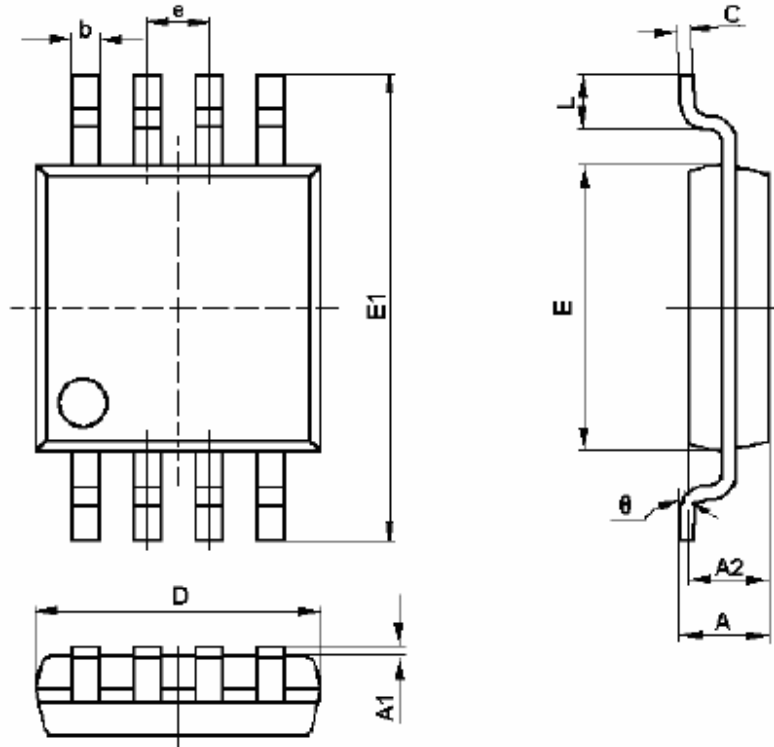

| Symbol | Dimensions In Millimeters | | Dimensions In Inches | |
|--------|---------------------------|-------|----------------------|-------|
| | Min | Max | Min | Max |
| A | 0.800 | 1.200 | 0.031 | 0.047 |
| A1 | 0.000 | 0.200 | 0.000 | 0.008 |
| A2 | 0.760 | 0.970 | 0.030 | 0.038 |
| b | 0.30 TYP | | 0.012 TYP | |
| c | 0.15 TYP | | 0.006 TYP | |
| D | 2.900 | 3.100 | 0.114 | 0.122 |
| e | 0.65 TYP | | 0.026 TYP | |
| E | 2.900 | 3.100 | 0.114 | 0.122 |
| E1 | 4.700 | 5.100 | 0.185 | 0.201 |
| L | 0.410 | 0.650 | 0.016 | 0.026 |
| theta | 0° | 6° | 0° | 6° |

PACKAGE OUTLINE DIMENSIONS

CSP-9

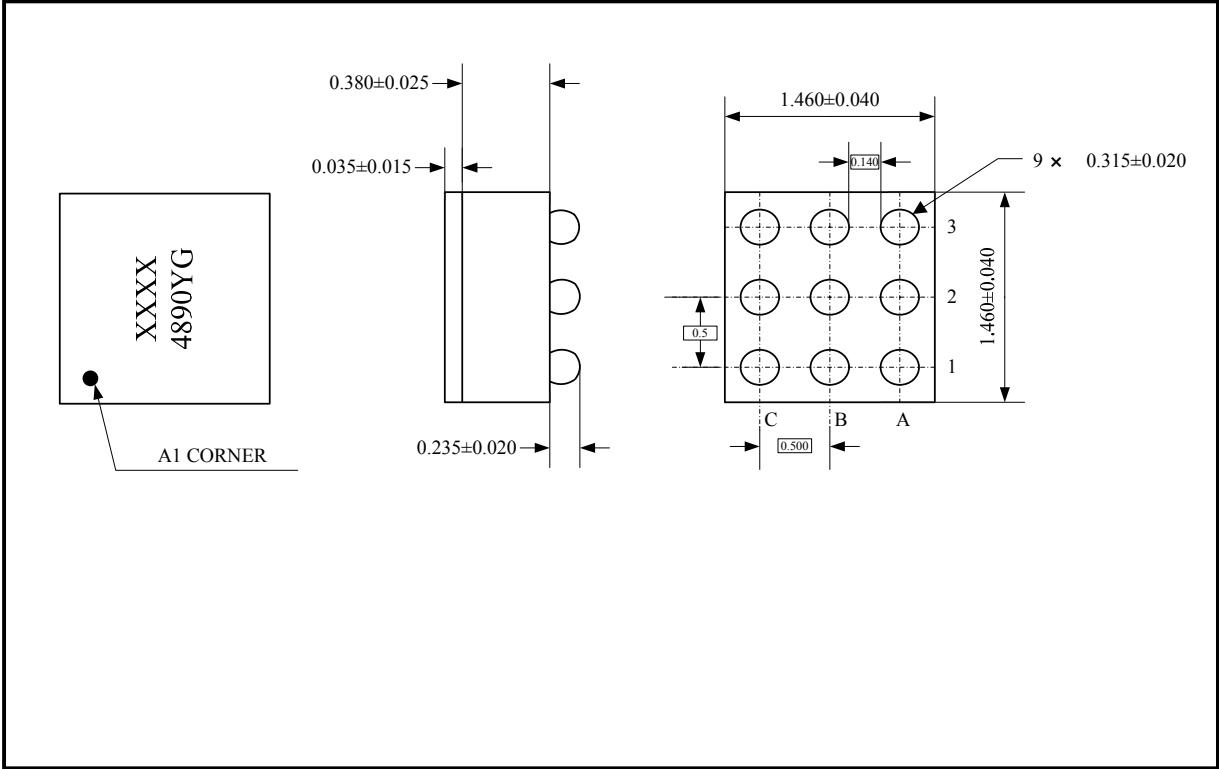

Note: All linear dimensions are in millimeters.

REVISION HISTORY

| Location | Page |
|-------------------------------|------|
| 09/2007—Preliminary Datasheet | |
| 11/2007—Data Sheet REV.A | |

SG Microelectronics Co., Ltd

A2608, NO.72 North Road
Xisanhuan, Haidian District,
Beijing, China 100037
Tel: 86-10-51798160/80
Fax: 86-10-51798180-803
www.sg-micro.com