

GENERAL DESCRIPTION

The SGM2022 is a dual, low-power, low-dropout, CMOS linear voltage regulators. It operates from a 2.5V to 4.5V input and delivers up to 150mA at each channel.

The SGM2022 is the perfect choice for low voltage, low power and RF applications. A low ground current 160 μ A (both LDO's enabled and active) makes this part attractive for battery operated power systems. The SGM2022 also offers low dropout voltage (135mV at 150mA output) to prolong battery life in portable electronics.

Separate enable pins control each individual LDO output. The EN function allows the output of each regulator to be turned off independently, resulting in greatly reduced power consumption. Other features include a 10nA logic-controlled shutdown mode, foldback current limit and thermal shut- down protection.

Devices come in 6-pin SOT23 package.

APPLICATIONS

Cellular Telephones
 Cordless Telephones
 PCS Telephones
 PCMCIA Cards
 Modems
 MP3 Player
 Hand-Held Instruments
 Palmtop Computers
 Wireless LAN
 Portable/Battery-Powered Equipment

FEATURES

- **Highly Accurate: 2%**
- **Ultra-Low Dropout Voltage:
135mV at 150mA output**
- **Low 160 μ A No-Load Supply Current**
- **Low 300 μ A Operating Supply Current
at 150mA Output**
- **Thermal-Overload Protection**
- **Output Current Limit**
- **10nA Logic-Controlled Shutdown**
- **Operating Temperature Range : -40 $^{\circ}$ C to 85 $^{\circ}$ C**
- **Small Package**

PIN CONFIGURATIONS (TOP VIEW)

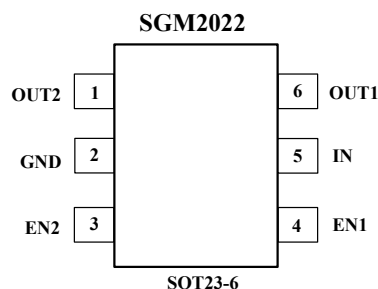

TYPICAL OPERATION CIRCUIT

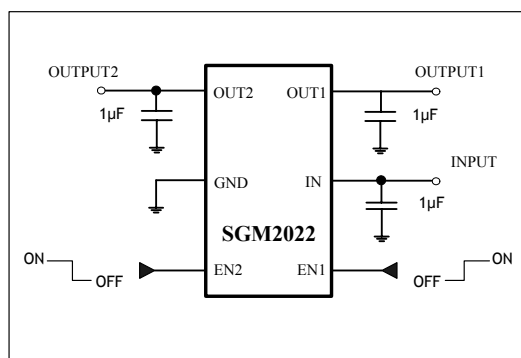

ORDERING INFORMATION

ORDERING NUMBER	V _{OUT1}	V _{OUT2}	PIN-PACKAGE	SPECIFIED TEMPERATURE RANGE	PACKAGE MARKING	PACKAGE OPTION
SGM2022-AYN6/TR	2.8V	2.8V	SOT23-6	- 40°C to +85°C	2022A	Tape and Reel, 3000
SGM2022-CYN6/TR	2.8V	3.0V	SOT23-6	- 40°C to +85°C	2022C	Tape and Reel, 3000
SGM2022-DYN6/TR	2.8V	2.5V	SOT23-6	- 40°C to +85°C	2022D	Tape and Reel, 3000
SGM2022-EYN6/TR	2.8V	1.8V	SOT23-6	- 40°C to +85°C	2022E	Tape and Reel, 3000
SGM2022-GYN6/TR	2.5V	1.8V	SOT23-6	- 40°C to +85°C	2022G	Tape and Reel, 3000
SGM2022-HYN6/TR	3.3V	2.5V	SOT23-6	- 40°C to +85°C	2022H	Tape and Reel, 3000
SGM2022-IYN6/TR	3.3V	1.8V	SOT23-6	- 40°C to +85°C	2022I	Tape and Reel, 3000
SGM2022-KYN6/TR	3.0V	1.8V	SOT23-6	- 40°C to +85°C	2022K	Tape and Reel, 3000

ABSOLUTE MAXIMUM RATINGS

IN to GND.....- 0.3V to +5V
 Output Short-Circuit DurationInfinite
 EN to GND.....- 0.3V to +5V
 OUT to GND.....- 0.3V to (V_{IN} + 0.3V)
 Power Dissipation, P_D @ T_A = 25°C
 SOT23-60.24W
 Package Thermal Resistance
 SOT23-6, θ_{JA}..... 250°C/W

Operating Temperature Range.....- 40°C to +85°C
 Junction Temperature.....+150°C
 Storage Temperature.....- 65°C to +150°C
 Lead Temperature (soldering, 10s).....260°C
 ESD Susceptibility
 HBM.....4000V
 MM.....400V

Stresses beyond those listed under “Absolute Maximum Ratings” may cause permanent damage to the device. These are stress ratings only, and functional operation of the device at these or any other conditions beyond those indicated in the operational sections of the specifications is not implied. Exposure to absolute maximum rating conditions for extended periods may affect device reliability.

PIN DESCRIPTION

PIN	NAME	FUNCTION
1	OUT2	Channel 2 Output Voltage
2	GND	Common Ground.
3	EN2(1)	On/Off Control 2, A logic low reduces the supply current to 10nA.
4	EN1(1)	On/Off Control 1, A logic low reduces the supply current to 10nA.
5	IN	Supply Input.
6	OUT1	Channel 2 Output Voltage

Note(1): If EN1 and EN2 are both low, both regulators and the reference turn off.

ELECTRICAL CHARACTERISTICS

($V_{IN} = V_{OUT(NOMINAL)} + 0.5V$ or $2.5V$ (whichever is greater), $T_A = -40^{\circ}C$ to $+85^{\circ}C$, Typical values are at $T_A = +25^{\circ}C$, for each LDO unless otherwise specified.)

PARAMETER	SYMBOL	CONDITIONS		MIN	TYP	MAX	UNITS
Input Voltage	V_{IN}			2.5		4.5	V
Output Voltage Accuracy		$I_{OUT} = 0.1mA$, $V_{OUT} \geq 2.5V$, $T_A = +25^{\circ}C$				2	%
Maximum Output Current				150			mA
Current Limit	I_{LIM}			160	500		mA
Ground Pin Current	I_Q	EN= 2V, both LDOs	No load		160		μA
			$I_{OUT} = 150mA$		300		
Dropout Voltage (Note1)		$I_{OUT} = 1mA$			0.9		mV
		$I_{OUT} = 150mA$			135	200	
Line Regulation	ΔV_{LNR}	$V_{IN} = 2.5V$ or ($V_{OUT} + 0.5V$) to $4.5V$, $I_{OUT} = 1mA$			0.02	0.08	%/V
Load Regulation	ΔV_{LDR}	$I_{OUT} = 0.1mA$ to $150mA$, $C_{OUT} = 1\mu F$			0.004	0.01	%/mA
Power Supply Rejection Rate	PSRR	$I_{LOAD} = 50mA$, $C_{OUT} = 1\mu F$	$f = 100Hz$,		74		dB
SHUTDOWN							
EN Input Threshold	V_{IH}	$V_{IN} = 2.5V$ to $4.5V$		2.0			V
	V_{IL}					0.4	
EN Input Bias Current	$I_{B(SHDN)}$	EN = 0V and EN = 4.5V	$T_A = +25^{\circ}C$		0.02	5	μA
			$T_A = +85^{\circ}C$		0.02		
Shutdown Supply Current	$I_{Q(SHDN)}$	EN1 = EN2 = 0.4V	$T_A = +25^{\circ}C$		0.01	5	μA
			$T_A = +85^{\circ}C$		0.01		
Shutdown Exit Delay(Note2)		$C_{OUT} = 1\mu F$, No load	$T_A = +25^{\circ}C$		20		μs
THERMAL PROTECTION							
Thermal Shutdown Temperature	T_{SHDN}				160		$^{\circ}C$
Thermal Shutdown Hysteresis	ΔT_{SHDN}				15		$^{\circ}C$

Specifications subject to change without notice.

Note 1: The dropout voltage is defined as $V_{IN} - V_{OUT}$, when V_{OUT} is 100mV below the value of V_{OUT} for $V_{IN} = V_{OUT} + 0.5V$. (Only applicable for $V_{OUT} = +2.5V$ to $+3.3V$)

Note 2: Time needed for V_{OUT} to reach 95% of final value.

TYPICAL OPERATING CHARACTERISTICS

$V_{IN} = V_{OUT(NOMINAL)} + 0.5V$ or $2.5V$ (whichever is greater), $C_{IN} = 1\mu F$, $C_{OUT} = 1\mu F$, $T_A = +25^\circ C$, unless otherwise noted.

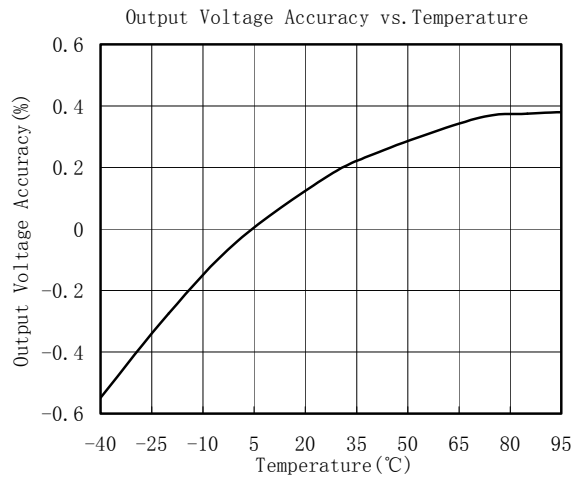
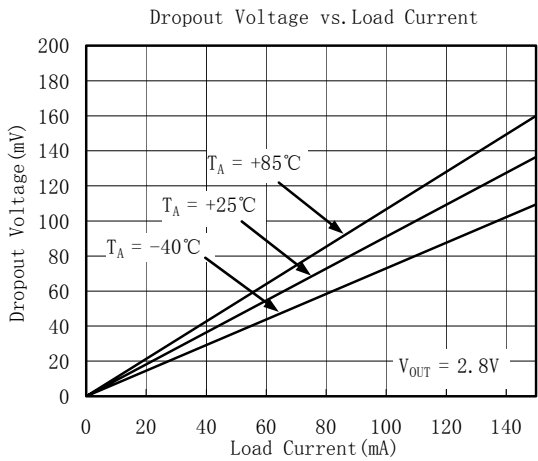
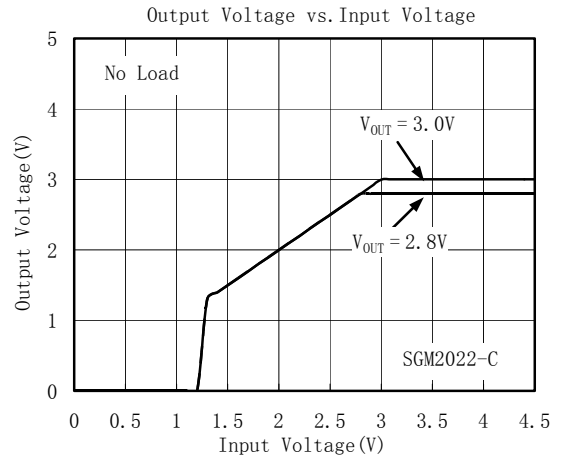
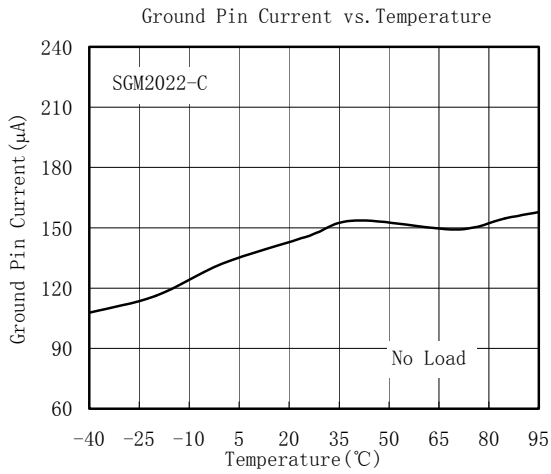
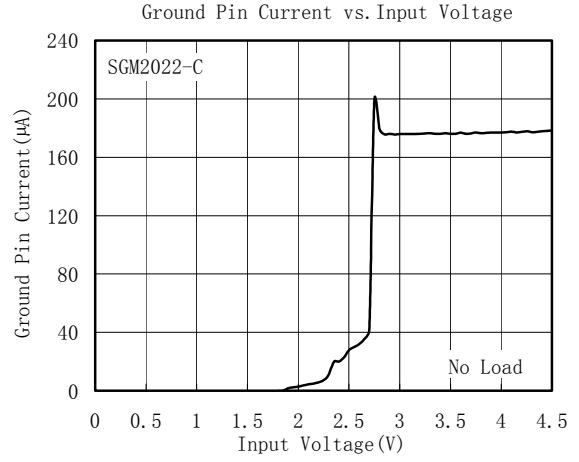
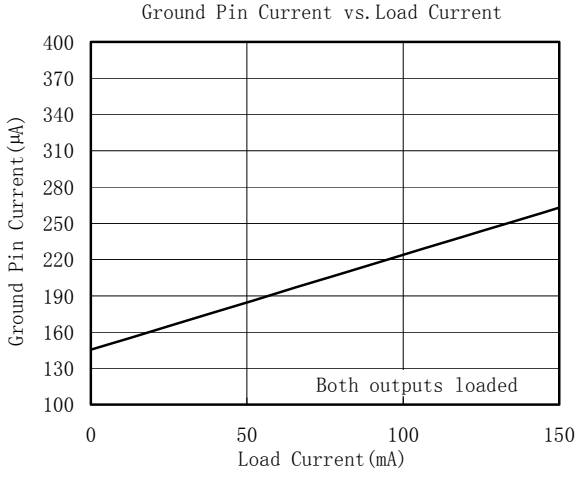

TYPICAL OPERATING CHARACTERISTICS

$V_{IN} = V_{OUT(NOMINAL)} + 0.5V$ or $2.5V$ (whichever is greater), $C_{IN} = 1\mu F$, $C_{OUT} = 1\mu F$, $T_A = +25^\circ C$, unless otherwise noted.

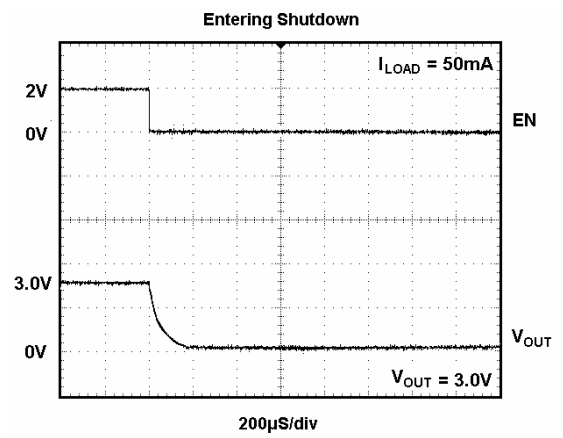
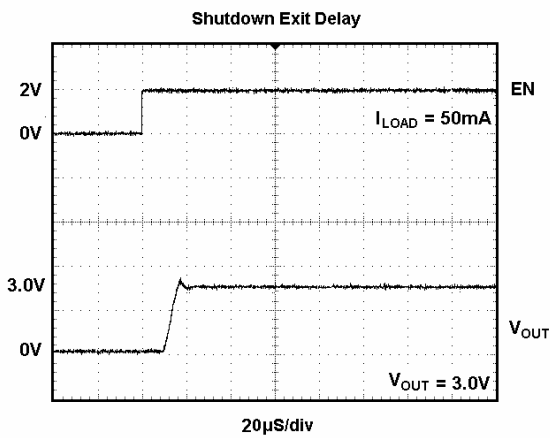
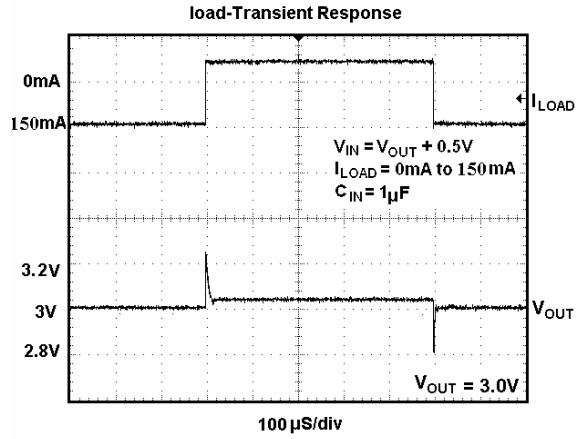
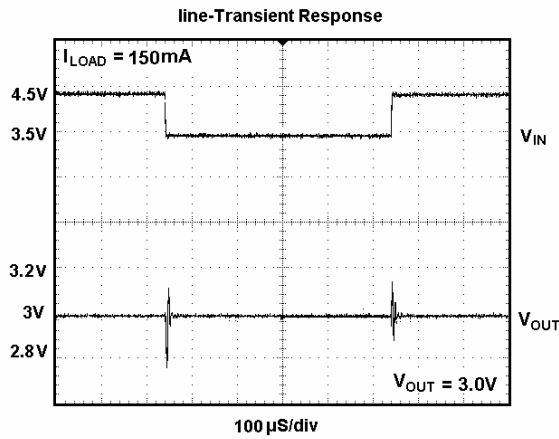
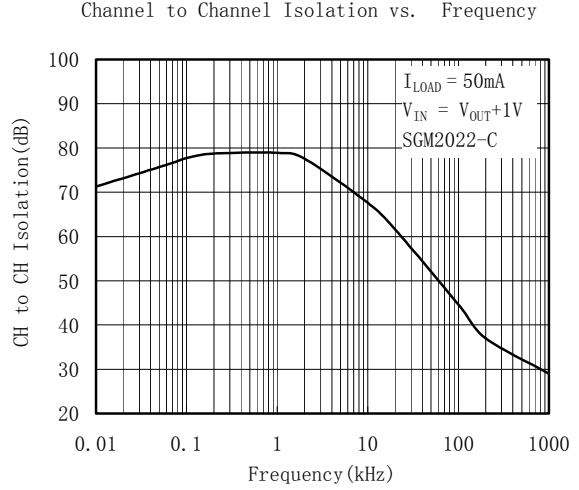
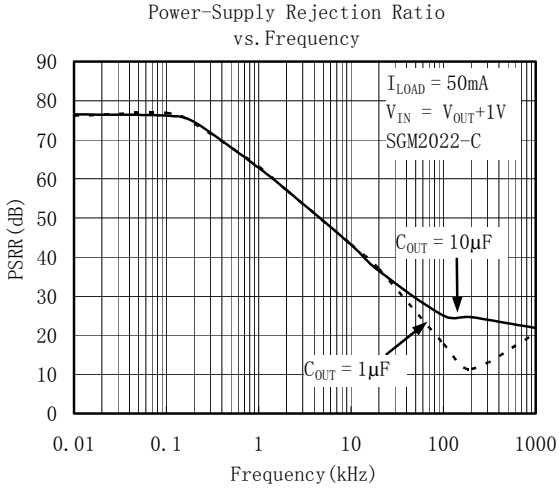

TYPICAL OPERATING CHARACTERISTICS

$V_{IN} = V_{OUT(NOMINAL)} + 0.5V$ or $2.5V$ (whichever is greater), $C_{IN} = 1\mu F$, $C_{OUT} = 1\mu F$, $T_A = +25^\circ C$, unless otherwise noted.

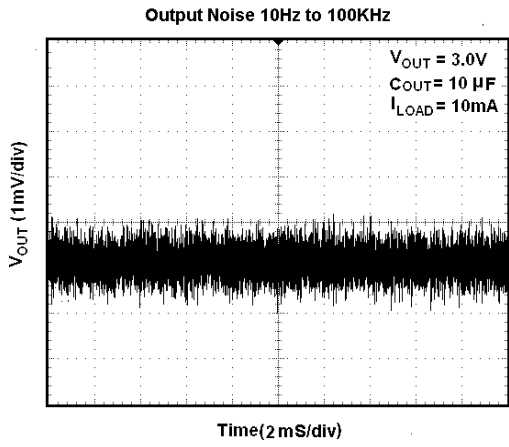

PACKAGE OUTLINE DIMENSIONS

SOT23-6

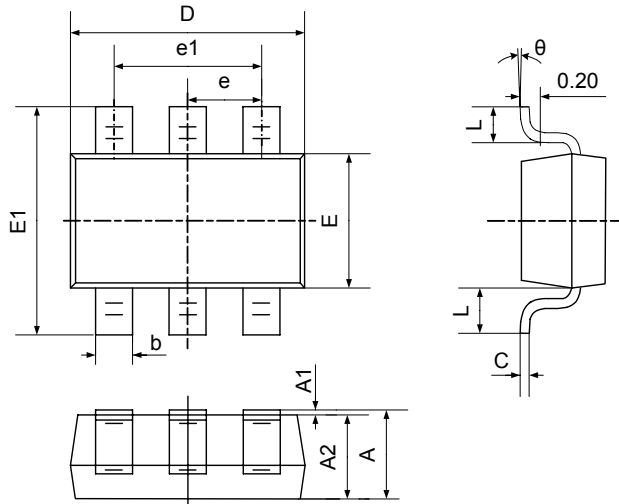

Symbol	Dimensions In Millimeters		Dimensions In Inches	
	Min	Max	Min	Max
A	1.050	1.250	0.041	0.049
A1	0.000	0.100	0.000	0.004
A2	1.050	1.150	0.041	0.045
b	0.300	0.400	0.012	0.016
c	0.100	0.200	0.004	0.008
D	2.820	3.020	0.111	0.119
E	1.500	1.700	0.059	0.067
E1	2.650	2.950	0.104	0.116
e	0.950TYP		0.037TYP	
e1	1.800	2.000	0.071	0.079
L	0.700REF		0.028REF	
L1	0.300	0.600	0.012	0.024
θ	0°	8°	0°	8°

REVISION HISTORY

Location

Page

01/07— Data Sheet changed from Preliminary to REV. A

Shengbang Microelectronics Co, Ltd

Unit 3, ChuangYe Plaza
No.5, TaiHu Northern Street, YingBin Road Centralized Industrial Park
Harbin Development Zone
Harbin, HeiLongJiang 150078
P.R. China
Tel.: 86-451-84348461
Fax: 86-451-84308461
www.sg-micro.com