

## GENERAL DESCRIPTION

The SGM2014 series low-power, low-noise, low-dropout, CMOS linear voltage regulators operate from a 2.5V to 5.5V input and deliver up to 250mA. They are the perfect choice for low voltage, low power applications. An ultra low ground current (160 $\mu$ A at 250mA output) makes these part attractive for battery operated power systems. The SGM2014 series also offer ultra low dropout voltage (250mV at 250mA output) to prolong battery life in portable electronics. Systems requiring a quiet voltage source, such as RF applications, will benefit from the SGM2014 series' ultra low output noise (30 $\mu$ VRMS) and high PSRR. An external noise bypass capacitor connected to the device's BP pin can further reduce the noise level.

The output voltage is preset to voltages in the range of 1.5V to 3.3V. Other features include a 10nA logic-controlled shutdown mode, output current limit and thermal shut- down protection.

Devices come in 5-pin SOT23 package.

## APPLICATIONS

Cellular Telephones  
Cordless Telephones  
PHS Telephones  
PCMCIA Cards  
Modems  
MP3 Player  
Hand-Held Instruments  
Palmtop Computers  
Electronic Planners  
Portable/Battery-Powered Equipment

## FEATURES

- Low Output Noise: 30 $\mu$ VRMS TYP(10Hz to 100kHz)
- Ultra-Low Dropout Voltage:  
250mV at 250mA Output
- Low 85 $\mu$ A No-Load Supply Current
- Low 160 $\mu$ A Operating Supply Current  
at 250mA Output
- High PSRR (73dB at 1kHz)
- Quick Auto-Discharge in Shutdown Status
- Thermal-Overload Protection
- Output Current Limit
- 10nA Logic-Controlled Shutdown
- Available in Multiple Output Voltage Versions  
Fixed Outputs of 1.5V, 1.8V, 2.5V, 2.8V, 2.85V,  
3.0V, 3.3V

## PIN CONFIGURATION (TOP VIEW)

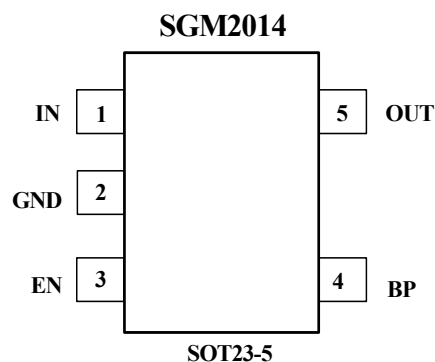

## ORDERING INFORMATION

MODEL	V <sub>OUT</sub> (V)	PIN-PACKAGE	SPECIFIED TEMPERATURE RANGE	ORDERING NUMBER	PACKAGE MARKING	PACKAGE OPTION
SGM2014-1.5	1.5V	SOT23-5	- 40°C to +85°C	SGM2014-1.5YN5/TR	YE15	Tape and Reel, 3000
SGM2014-1.8	1.8V	SOT23-5	- 40°C to +85°C	SGM2014-1.8YN5/TR	YE18	Tape and Reel, 3000
SGM2014-2.5	2.5V	SOT23-5	- 40°C to +85°C	SGM2014-2.5YN5/TR	YE25	Tape and Reel, 3000
SGM2014-2.8	2.8V	SOT23-5	- 40°C to +85°C	SGM2014-2.8YN5/TR	YE28	Tape and Reel, 3000
SGM2014-2.85	2.85V	SOT23-5	- 40°C to +85°C	SGM2014-2.85YN5/TR	YE2J	Tape and Reel, 3000
SGM2014-3.0	3.0V	SOT23-5	- 40°C to +85°C	SGM2014-3.0YN5/TR	YE30	Tape and Reel, 3000
SGM2014-3.3	3.3V	SOT23-5	- 40°C to +85°C	SGM2014-3.3YN5/TR	YE33	Tape and Reel, 3000

## ABSOLUTE MAXIMUM RATINGS

IN to GND.....- 0.3V to +6V  
 Output Short-Circuit Duration .....Infinite  
 EN to GND.....- 0.3V to +6V  
 OUT, BP to GND.....- 0.3V to (V<sub>IN</sub> + 0.3V)  
 Power Dissipation, P<sub>D</sub> @ T<sub>A</sub> = 25°C  
 SOT23-5 .....0.4W  
 Package Thermal Resistance  
 SOT23-5, θ<sub>JA</sub>..... 250°C/W

Operating Temperature Range.....- 40°C to +85°C  
 Junction Temperature.....+150°C  
 Storage Temperature.....- 65°C to +150°C  
 Lead Temperature (soldering, 10s).....260°C  
 ESD Susceptibility  
 HBM.....4000V  
 MM.....400V

Stresses beyond those listed under “Absolute Maximum Ratings” may cause permanent damage to the device. These are stress ratings only, and functional operation of the device at these or any other conditions beyond those indicated in the operational sections of the specifications is not implied. Exposure to absolute maximum rating conditions for extended periods may affect device reliability.

## BLOCK DIAGRAM

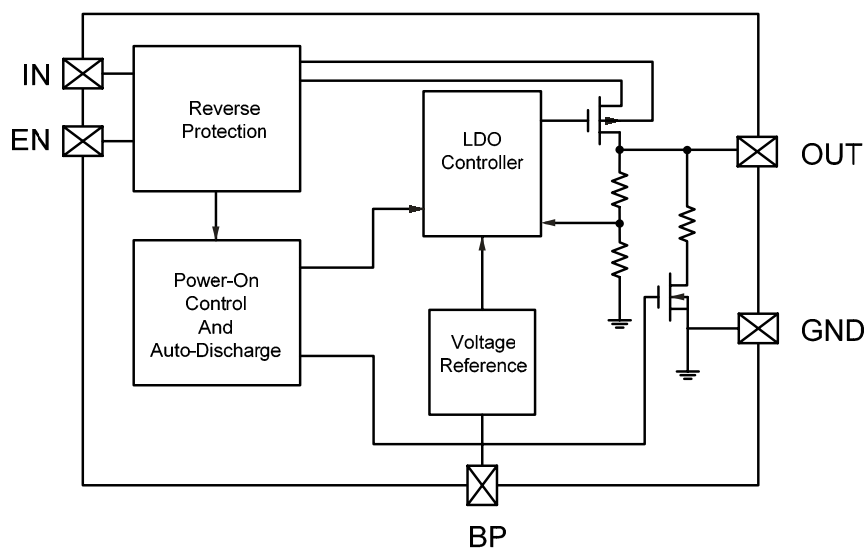

# ELECTRICAL CHARACTERISTICS

$V_{IN} = V_{OUT(NOMINAL)} + 1V$ ,  $T_A = -40^{\circ}C$  to  $+85^{\circ}C$ , unless otherwise noted. Typical values are at  $T_A = +25^{\circ}C$

PARAMETER	SYMBOL	CONDITIONS	MIN	TYP	MAX	UNITS	
Input Voltage	$V_{IN}$		2.5		5.5	V	
Output Voltage Accuracy		$I_{OUT} = 0.1mA$ , $T_A = +25^{\circ}C$	-2		2	%	
		$I_{OUT} = 0.1mA$ to $250mA$ $T_A = -40^{\circ}C$ to $+85^{\circ}C$			2.6		
Maximum Output Current			250			mA	
Current Limit	$I_{LIM}$		260	450		mA	
Ground Pin Current	$I_Q$	No load, $EN = 1.6V$		85	135	$\mu A$	
		$I_{OUT} = 250mA$ , $EN = 1.6V$		160			
Dropout Voltage(Note1)		$I_{OUT} = 1mA$		1.2		mV	
		$I_{OUT} = 250mA$		250	400		
Line Regulation	$\Delta V_{LNR}$	$V_{IN} = 2.5V$ or $(V_{OUT} + 0.5V)$ to $5.5V$ $I_{OUT} = 1mA$		0.015	0.15	%/V	
Load Regulation	$\Delta V_{LDR}$	$I_{OUT} = 0.1mA$ to $250mA$ , $C_{OUT} = 1\mu F$		0.001	0.003	%/mA	
Output Voltage Noise	$e_n$	$f = 10Hz$ to $100kHz$ , $C_{BP} = 0.01\mu F$ , $C_{OUT} = 10\mu F$		30		$\mu VRMS$	
Power Supply Rejection Rate	PSRR	$C_{BP} = 0.1\mu F$ , $I_{LOAD} = 50mA$ , $C_{OUT} = 1\mu F$	$f = 100Hz$		76		dB
			$f = 1kHz$		73		dB
<b>SHUTDOWN</b>							
EN Input Threshold	$V_{IH}$	$V_{IN} = 2.5V$ to $5.5V$	1.6			V	
	$V_{IL}$				0.4		
EN Input Bias Current	$I_{B(SHDN)}$	$EN = 0V$ and $EN = 5.5V$	$T_A = +25^{\circ}C$		0.01	1	$\mu A$
			$T_A = +125^{\circ}C$		0.01		
Shutdown Supply Current	$I_{Q(SHDN)}$	$EN = 0.4V$	$T_A = +25^{\circ}C$		0.01	1	$\mu A$
			$T_A = +125^{\circ}C$		0.01		
Shutdown Exit Delay(Note2)		$C_{BP} = 0.01\mu F$ $C_{OUT} = 1\mu F$ , No load	$T_A = +25^{\circ}C$		30	$\mu s$	
<b>THERMAL PROTECTION</b>							
Thermal Shutdown Temperature	$T_{SHDN}$			160		$^{\circ}C$	
Thermal Shutdown Hysteresis	$\Delta T_{SHDN}$			10		$^{\circ}C$	

Specifications subject to change without notice.

**Note 1:** The dropout voltage is defined as  $V_{IN} - V_{OUT}$ , when  $V_{OUT}$  is 100mV below the value of  $V_{OUT}$  for  $V_{IN} = V_{OUT} + 1V$ . (Only applicable for  $V_{OUT} = +2.5V$  to  $+3.3V$ )

**Note 2:** Time needed for  $V_{OUT}$  to reach 95% of final value.

## TYPICAL OPERATION CIRCUIT

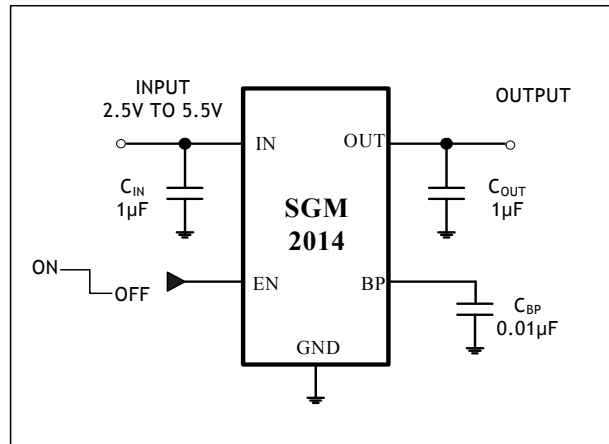

## PIN DESCRIPTION

PIN	NAME	FUNCTION
1	IN	Regulator Input. Supply voltage can range from 2.5V to 5.5V. Bypass with a 1µF capacitor to GND.
2	GND	Ground.
3	EN	Shutdown Input. A logic low reduces the supply current to 10nA. Connect to IN for normal operation.
4	BP	Reference-Noise Bypass. Bypass with a low-leakage 0.01µF ceramic capacitor for reduced noise at the output.
5	OUT	Regulator Output.

# TYPICAL OPERATING CHARACTERISTICS

$V_{IN} = V_{OUT(NOMINAL)} + 1V$  or  $+2.5V$  (whichever is greater),  $C_{IN} = 1\mu F$ ,  $C_{OUT} = 1\mu F$ ,  $C_{BP} = 0.01\mu F$ ,  $T_A = +25^\circ C$ , unless otherwise noted.

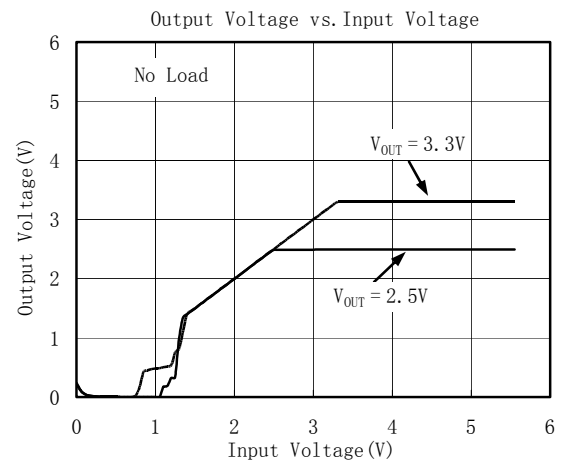
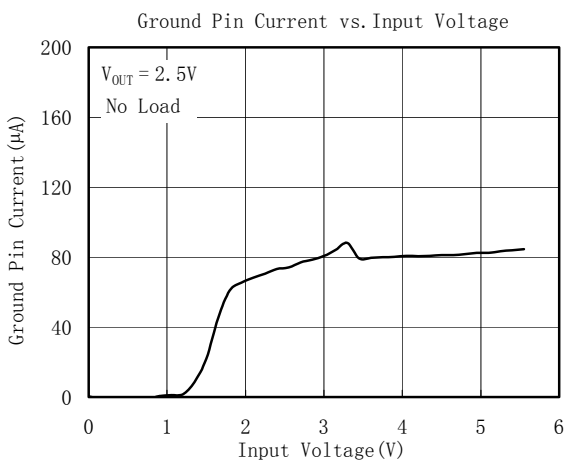
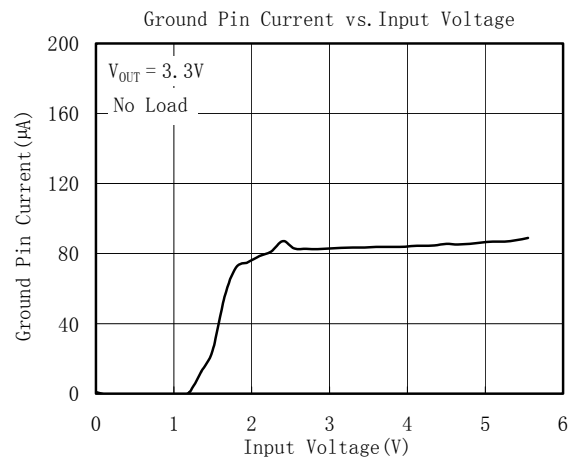
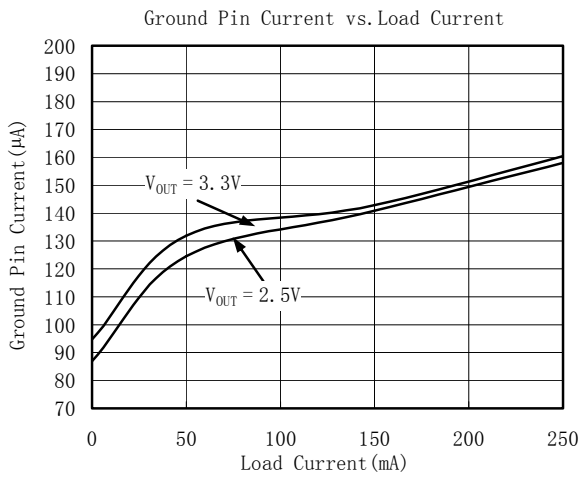
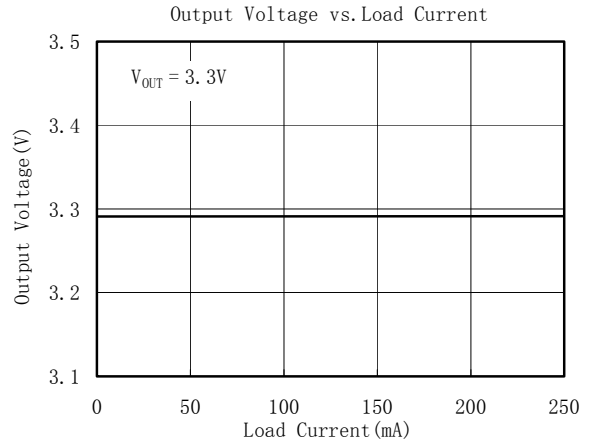
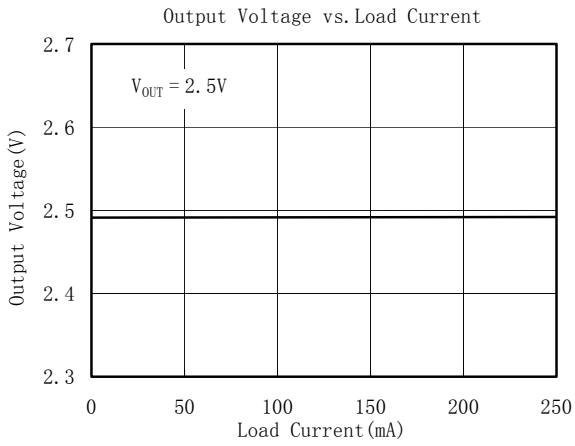

# TYPICAL OPERATING CHARACTERISTICS

$V_{IN} = V_{OUT(NOMINAL)} + 1V$  or  $+2.5V$  (whichever is greater),  $C_{IN} = 1\mu F$ ,  $C_{OUT} = 1\mu F$ ,  $C_{BP} = 0.01\mu F$ ,  $T_A = +25^\circ C$ , unless otherwise noted.

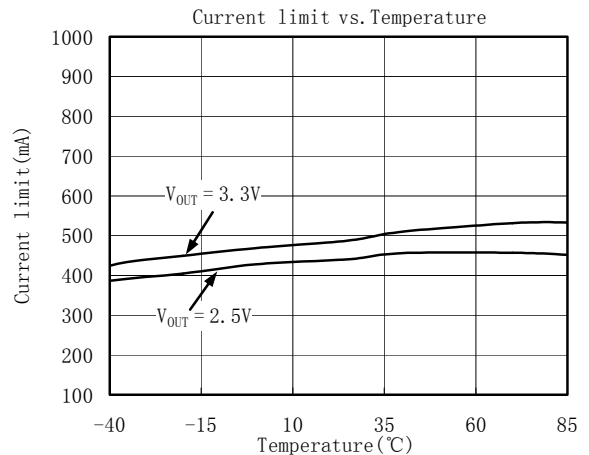
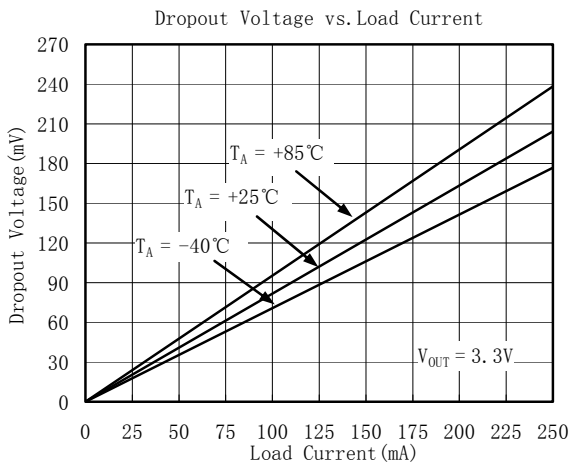
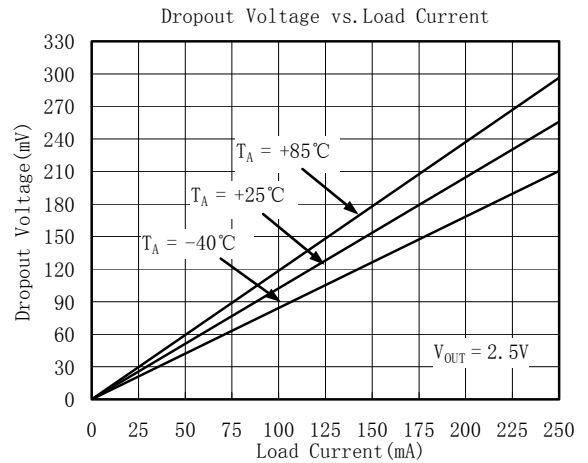
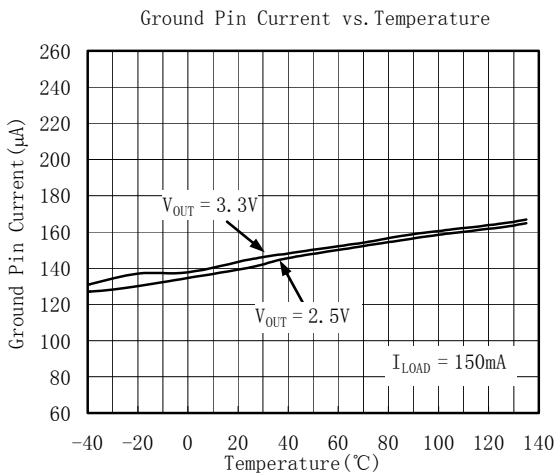
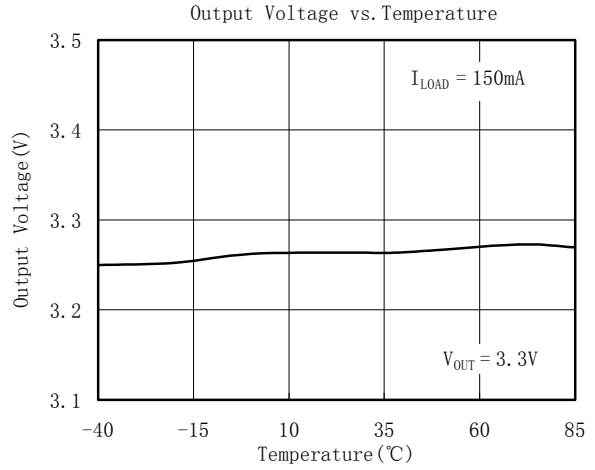
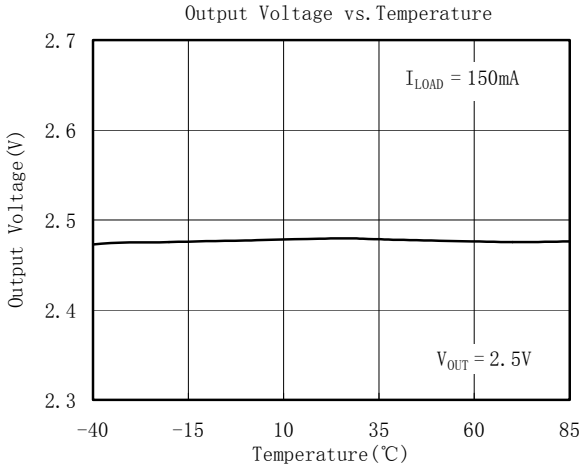

# TYPICAL OPERATING CHARACTERISTICS

$V_{IN} = V_{OUT(NOMINAL)} + 1V$  or  $+2.5V$  (whichever is greater),  $C_{IN} = 1\mu F$ ,  $C_{OUT} = 1\mu F$ ,  $C_{BP} = 0.01\mu F$ ,  $T_A = +25^\circ C$ , unless otherwise noted.

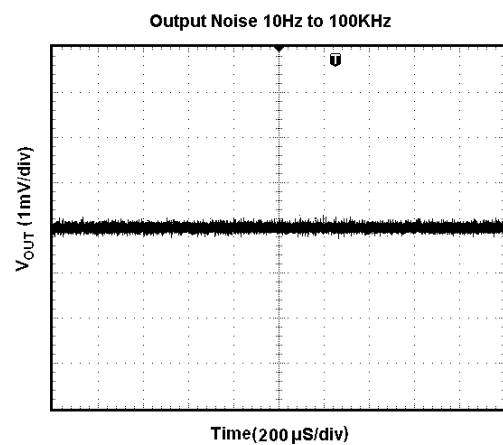
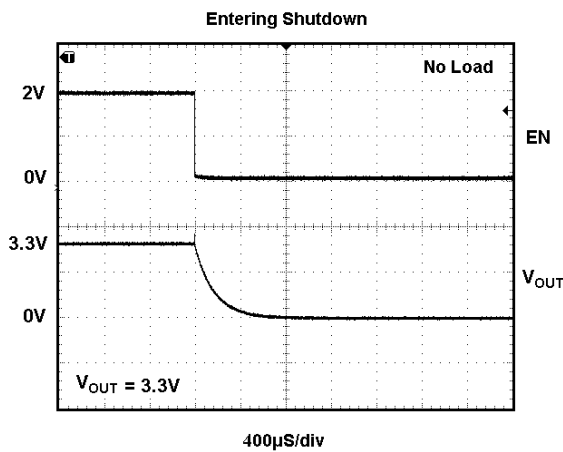
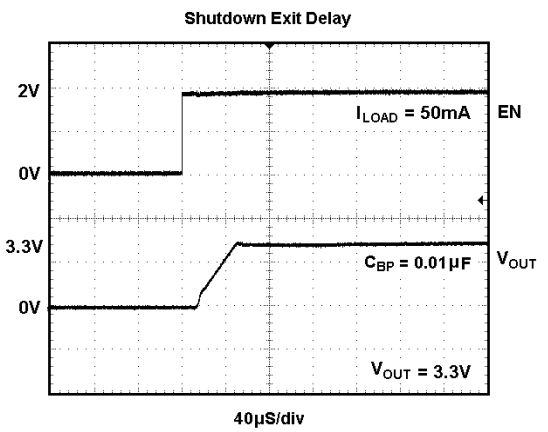
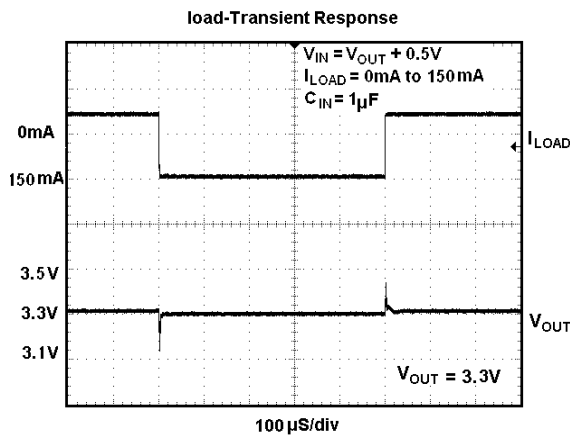
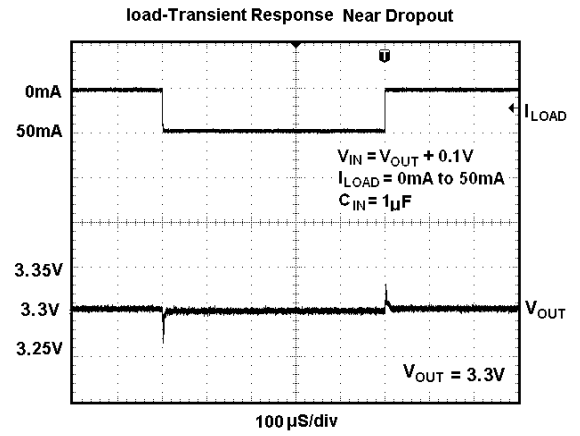
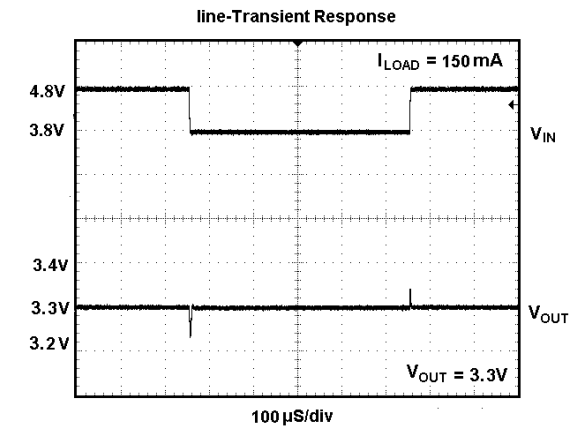

# TYPICAL OPERATING CHARACTERISTICS

$V_{IN} = V_{OUT(NOMINAL)} + 1V$  or  $+2.5V$  (whichever is greater),  $C_{IN} = 1\mu F$ ,  $C_{OUT} = 1\mu F$ ,  $C_{BP} = 0.01\mu F$ ,  $T_A = +25^\circ C$ , unless otherwise noted.

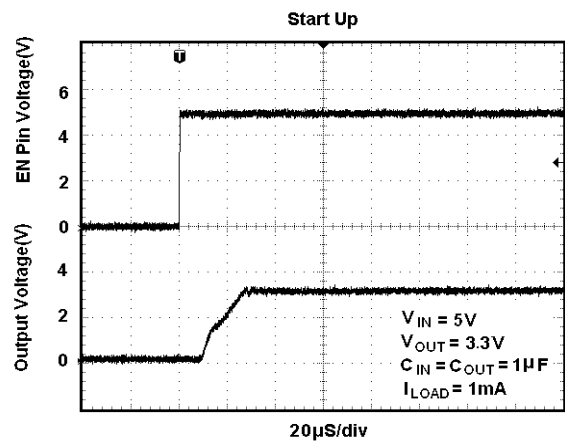
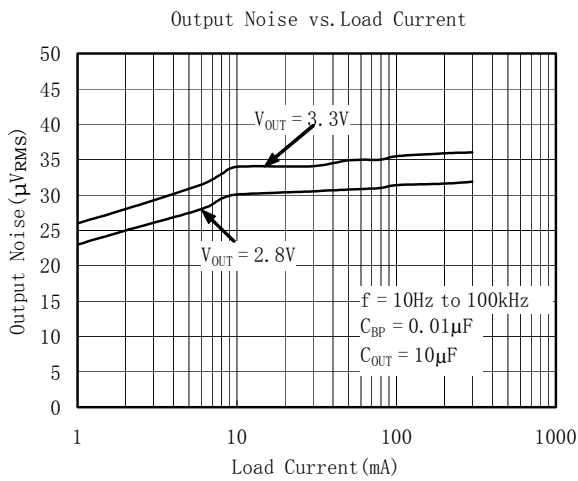
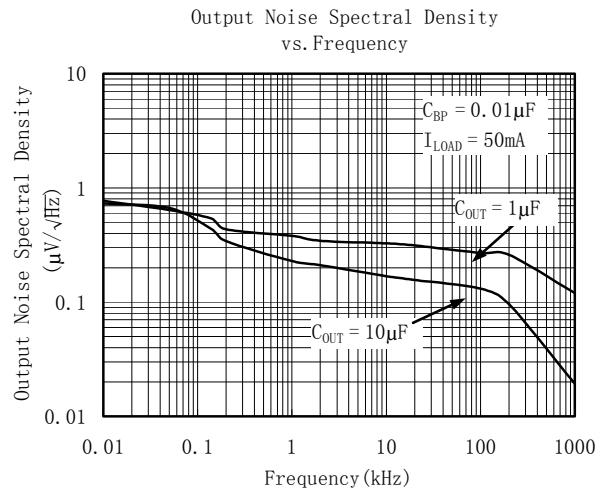
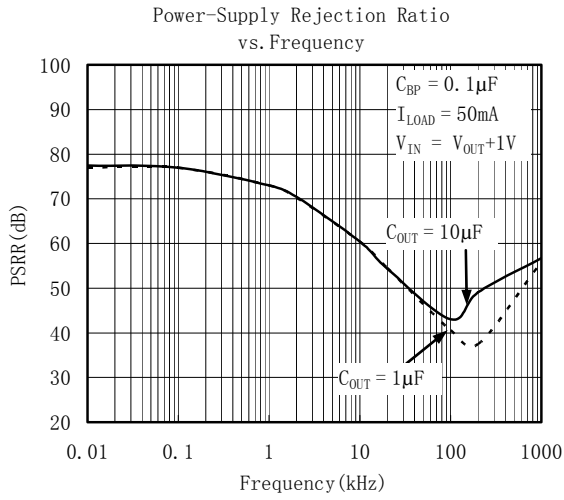



## APPLICATION NOTES

When LDO is used in handheld products, attention must be paid to voltage spikes which could damage SGM2014. In such applications, voltage spikes will be generated at charger interface and  $V_{BUS}$  pin of USB interface when charger adapters and USB equipments are hot-plugged. Besides this, handheld products will be tested on the production line without battery. Test engineer will apply power from the connector pin which connects with positive pole of the battery. When external power supply is turned on suddenly, the voltage spikes will be generated at the battery connector. The voltage spikes will be very high, and it always exceeds the absolute maximum input voltage (6.0V) of LDO. In order to get robust design, design engineer needs to clear up this voltage spike. Zener diode is a cheap and effective solution to eliminate such voltage spike. For example, BZM55B5V6 is a 5.6V small package Zener diode which can be used to remove voltage spikes in cell phone designs. The schematic is shown below.

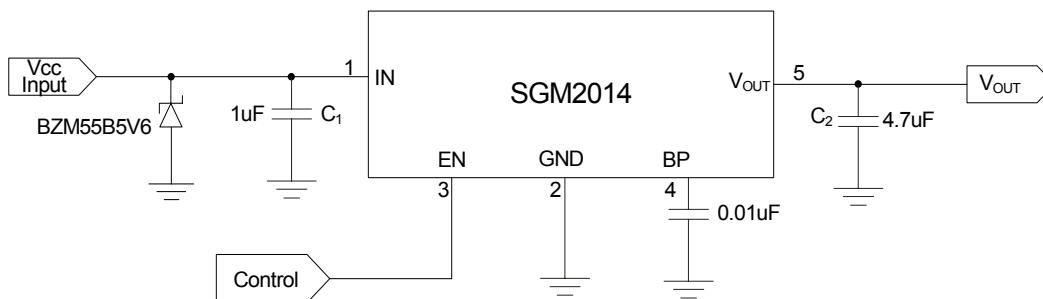

# PACKAGE OUTLINE DIMENSIONS

## SOT23-5

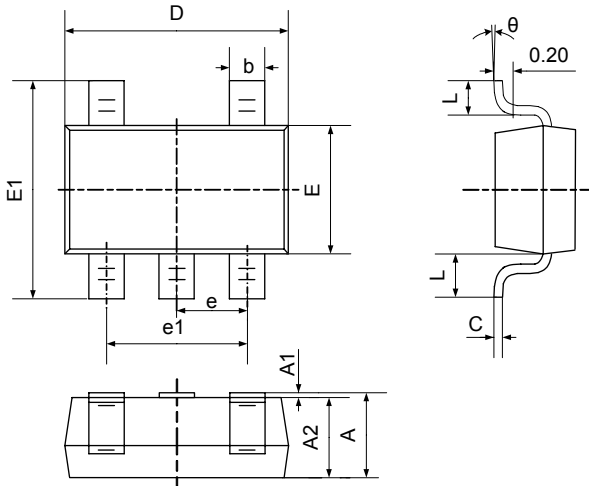

Symbol	Dimensions In Millimeters		Dimensions In Inches	
	Min	Max	Min	Max
A	1.050	1.250	0.041	0.049
A1	0.000	0.100	0.000	0.004
A2	1.050	1.150	0.041	0.045
b	0.300	0.400	0.012	0.016
c	0.100	0.200	0.004	0.008
D	2.820	3.020	0.111	0.119
E	1.500	1.700	0.059	0.067
E1	2.650	2.950	0.104	0.116
e	0.950TYP		0.037TYP	
e1	1.800	2.000	0.071	0.079
L	0.700REF		0.028REF	
L1	0.300	0.600	0.012	0.024
$\theta$	0°	8°	0°	8°

## REVISION HISTORY

Location

Page

---

08/2007— Data Sheet REV. A

### SG Microelectronics Co., Ltd

A2608, NO.72 North Road  
Xisanhuan, Haidian District,  
Beijing, China 100037  
Tel: 86-10-51798160/80  
Fax: 86-10-51798180-803  
[www.sg-micro.com](http://www.sg-micro.com)